

# A Guide to Movement Control

**Data Sheet 12**  
November 2017

Uniclass  
L3221 :A4  
EPIC  
F611 :X221  
CI/SfB  
Ff2 (Ajv)

## Introduction

After construction, buildings, especially the more modern slender constructions, are subject to small dimensional changes. The main movement in concrete masonry as it dries to equilibrium moisture content and the concrete carbonates is shrinkage. This data sheet gives guidance on how to accommodate such movements based on the rule of thumb:

Typical movement joint spacing for unreinforced concrete masonry panels:

- Internal: 8 to 12m
- External: 6 to 9m

Factors influencing spacing of joints are: mortar type/strength, (note: the weaker the mix, the increased ability to accommodate movement); use of bedjoint reinforcement and moisture content of blocks when laid.

Where possible, masonry should be designed as a series of panels, separated by movement control joints.

## Panels

Ideally panels should be square, but generally length should not exceed 3 x height of the panel, except where bedjoint reinforcement is introduced. Care therefore has to be taken when introducing wide window openings as the blockwork immediately above and below may exceed the 3 to 1 length/height ratio. Where possible storey height openings should be designed, forming the masonry into discrete panels without interfering with the overall design aspect. (See right).

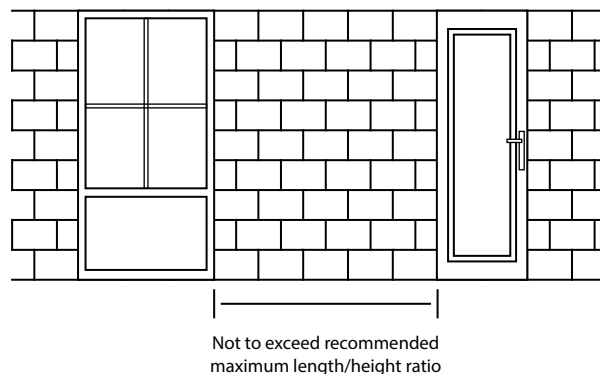

## A Guide to Movement Control

### Position of Movement Joints

Consideration for the location of movement joints should be given at:

- Change in wall height or thickness (See Figure 1 & Figure 2)
- Change of loading (See figure 3)
- Abutments of walls and columns (See Figure 4)
- Junctions of dissimilar materials (See Figure 5)
- Movement joints in concrete floor slabs (See Figure 6)
- Return angles in L, T and U shaped masonry panels (See Figure 7)
- Chases, recesses or openings (See Figure 8)

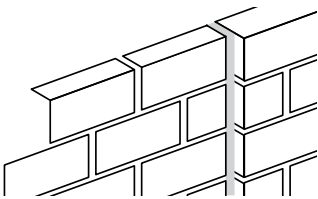

Fig. 1

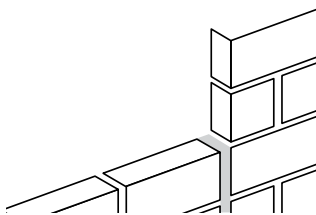

Fig. 2

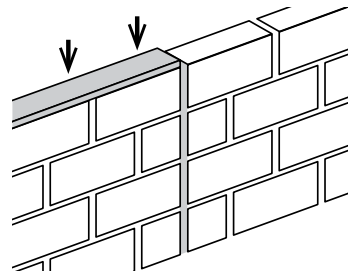

Fig. 3

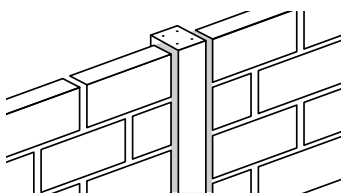

Fig. 4

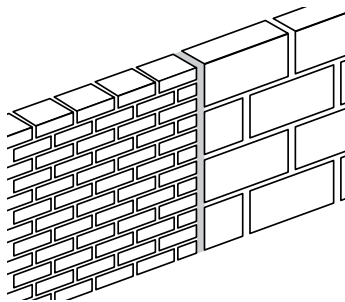

Fig. 5

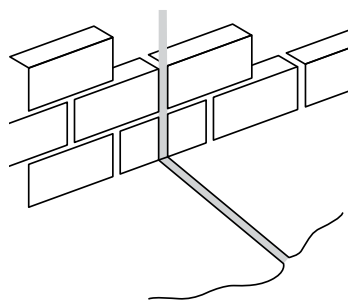

Fig. 6

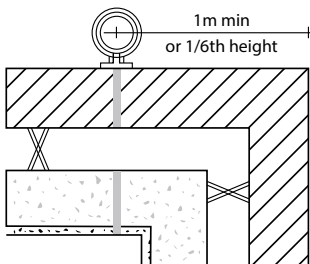

Fig. 7

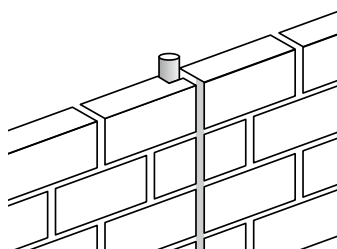

Fig. 8

## A Guide to Movement Control

### Bedjoint Reinforcement

The inclusion of ladder type bed joint reinforcement is recommended in two courses, one above and one below openings, to dissipate the extra stresses created around openings. (See Figure 9 & Figure 10).

Bedjoint reinforcement can also be used to reduce the incidence of movement joints as well as improving the lateral stability of masonry walls. (See Table 1).

Note: Bedjoint reinforcement should never bridge a movement control joint.

Due to the variations in physical properties between different concrete blocks, the manufacturer should be consulted for more specific guidance.

#### TYPICAL SPACING OF MOVEMENT JOINTS

Un-reinforced blockwork	9m
Reinforced at 675mm vertical centres	12m
Reinforced at 450mm vertical centres	14m
Reinforced at 225mm vertical centres	16m

Table 1

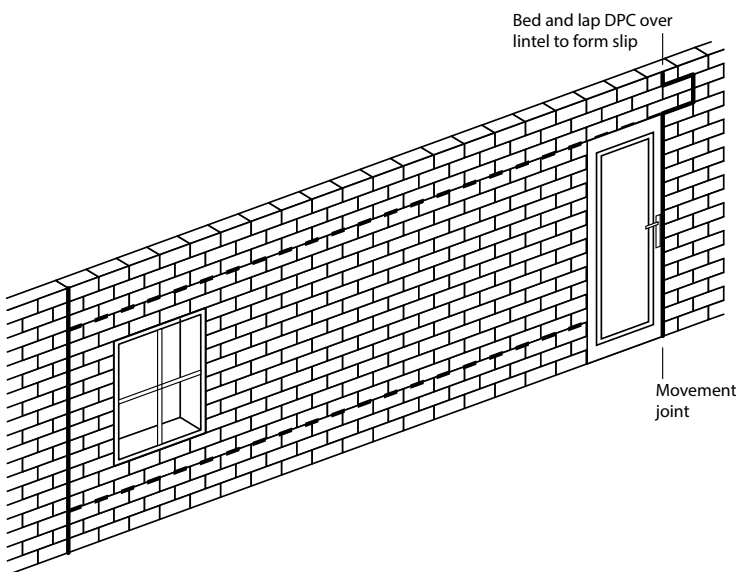

Fig. 9

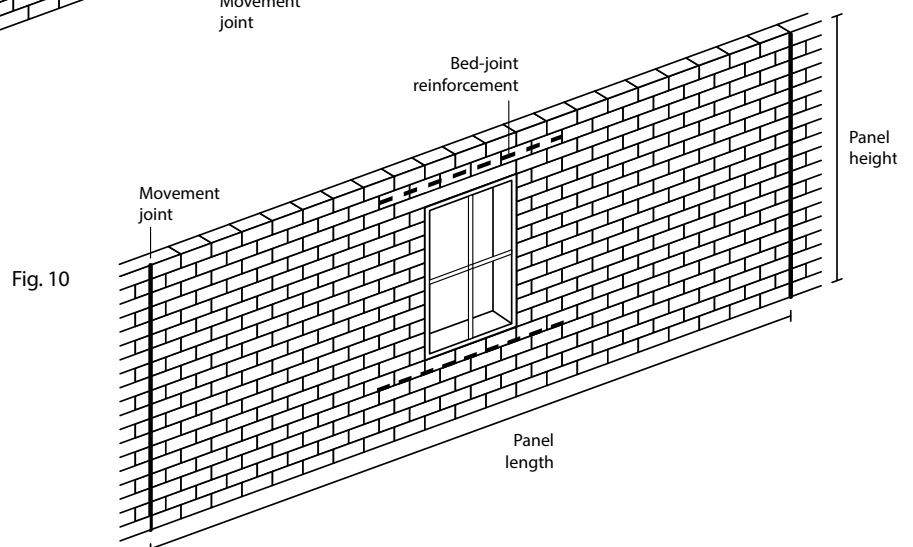

Fig. 10

## A Guide to Movement Control

### Joints

Joints should normally be 10mm wide and filled with a compressible filler such as a 13mm polyethylene foam strip, with a bond breaker and finished with a suitable sealant, such as a 2 part polysulphide when used externally (see Figure 11). Where masonry has an applied finish such as render/plaster or tiling, the joint should be continuous through the finishes (see Figure 12). Where the movement control joint is bridged by flat ties to improve lateral stability, one end should be debonded by the use of a PVC sleeve. Consideration should be given to the effects of fire, sound and stability when introducing a movement control joint.

### Deflection

It is important that any deflection from a floor or a roof is not transmitted to a non-loadbearing wall. If the anticipated deflection is not excessive, the joint may be packed with a compressible filler, such as mineral wool or a fire resistant foam (see Figure 13). This joint can be hidden from view by fixing a coving which should be fixed to the soffit only.

### General

Shrinkage of blockwork can be minimised by laying dry blocks and by protecting the work as it proceeds.

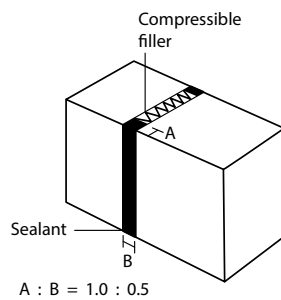

Fig. 11

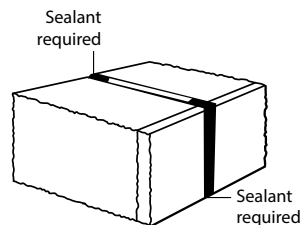

Fig. 12

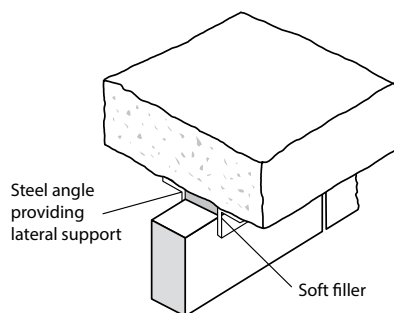

Fig. 13

© The Concrete Block Association 2017

Visit [www.cba-blocks.org.uk](http://www.cba-blocks.org.uk) for the latest information, news and views from the CBA. CBA Technical Helpline: 0116 232 5165

Although The Concrete Block Association does its best to ensure that any advice, recommendation or information it may give is accurate, no liability or responsibility of any kind (including liability for negligence) is accepted in this respect by the Association, its servants or agents.

This datasheet is manufactured using papers from either well managed sources or recycled stocks that are manufactured to ISO 14001 and are chlorine free.